

# Artemide®

## Tolomeo mega

design  
M. De Lucchi  
G. Fassina

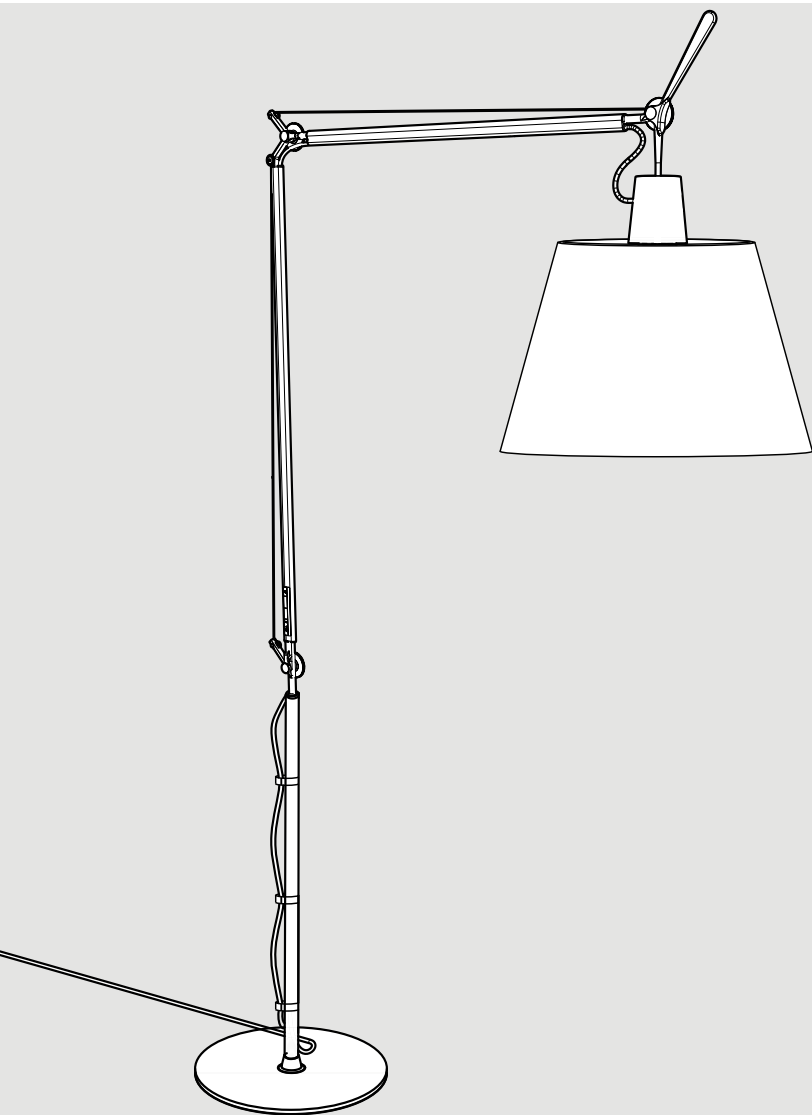



i

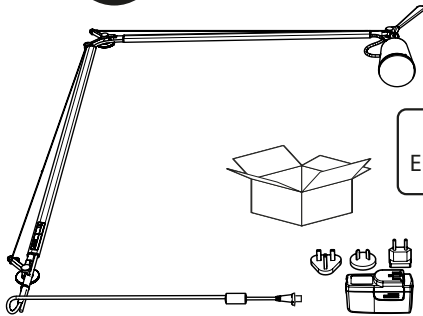
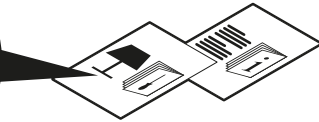
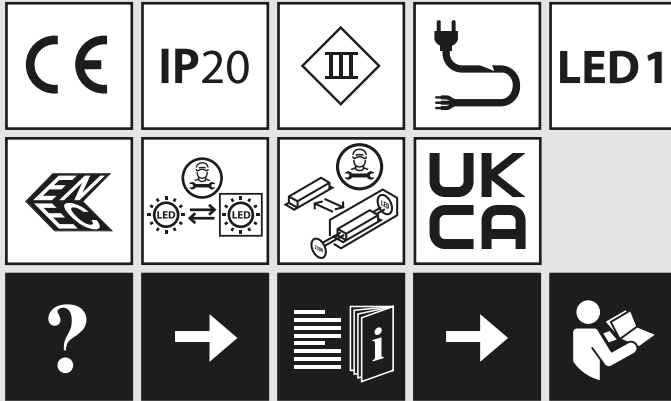

SELV  
EN 61347-2-13

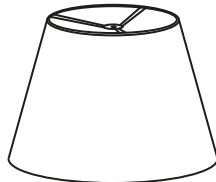
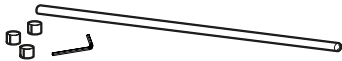
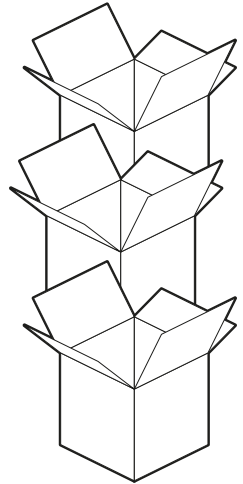
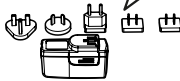

1

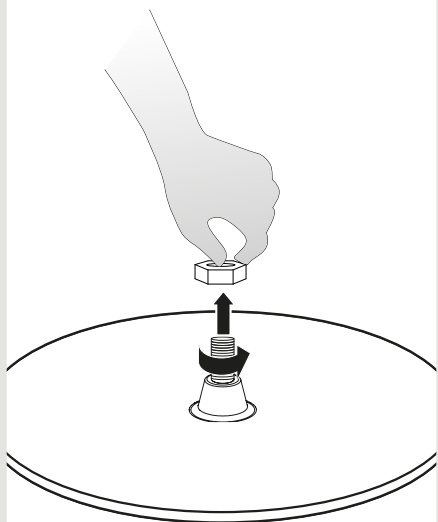

2

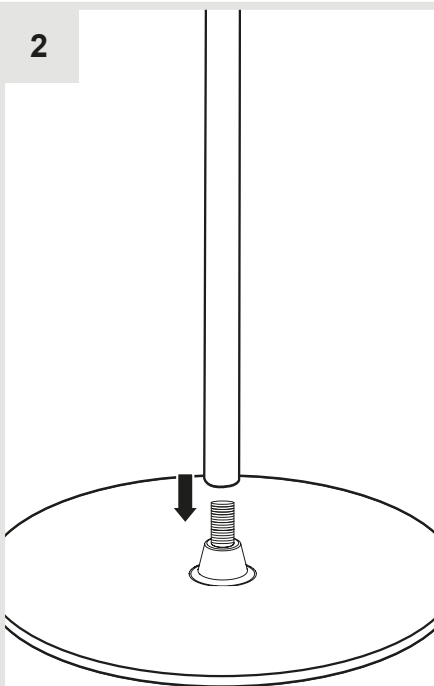

3

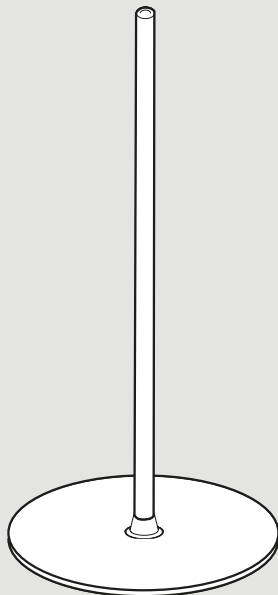
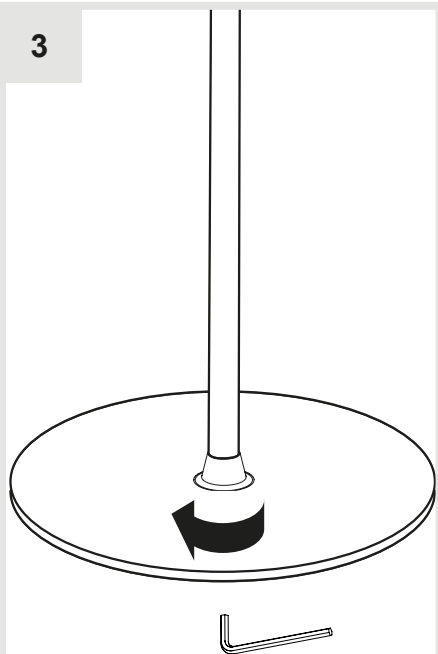

4

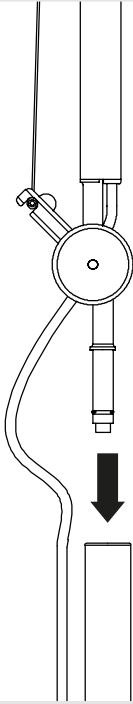

5

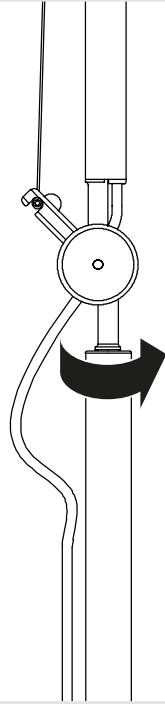

6

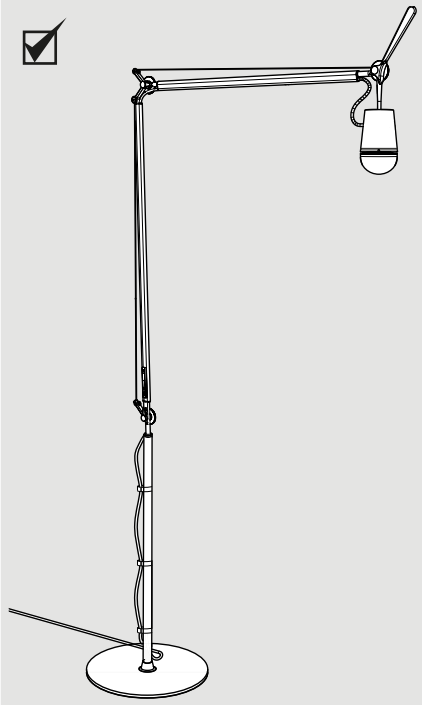
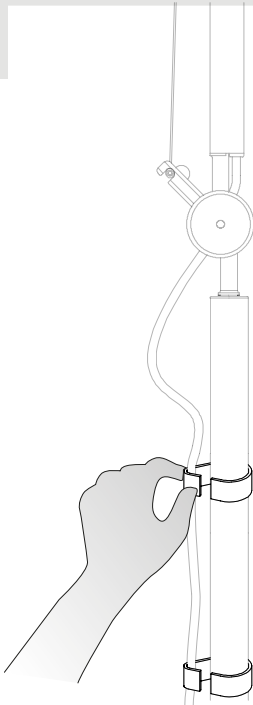

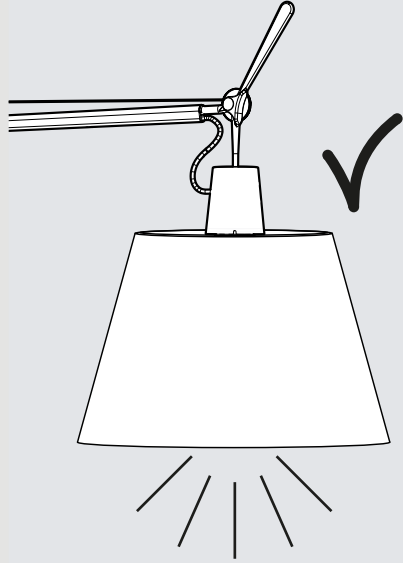
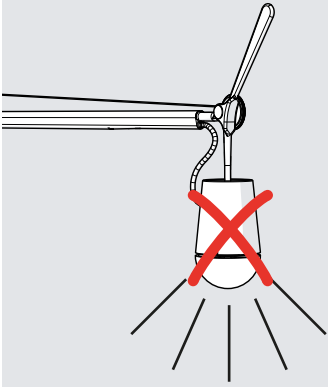

7

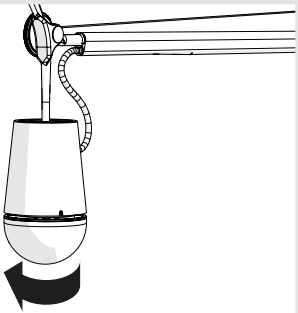

9



8

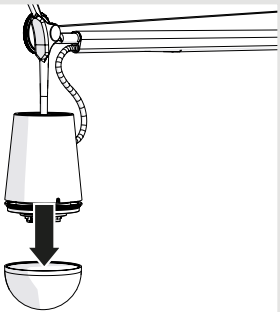

10



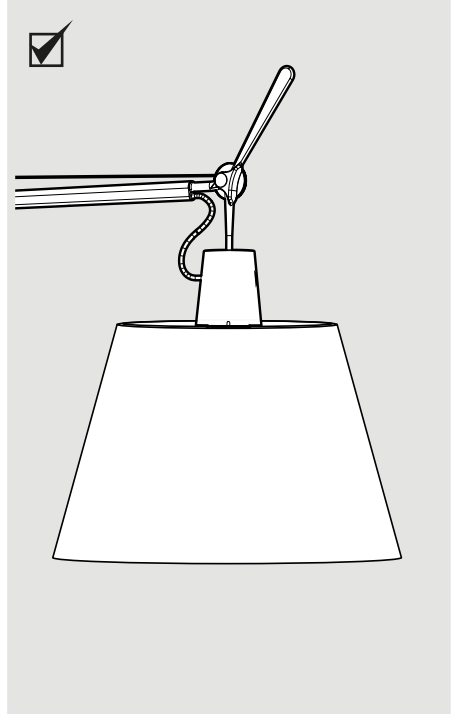
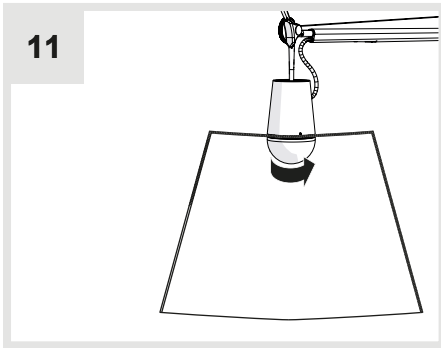
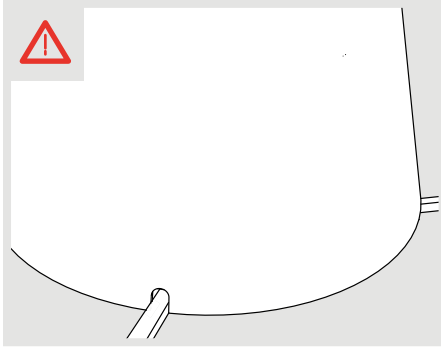

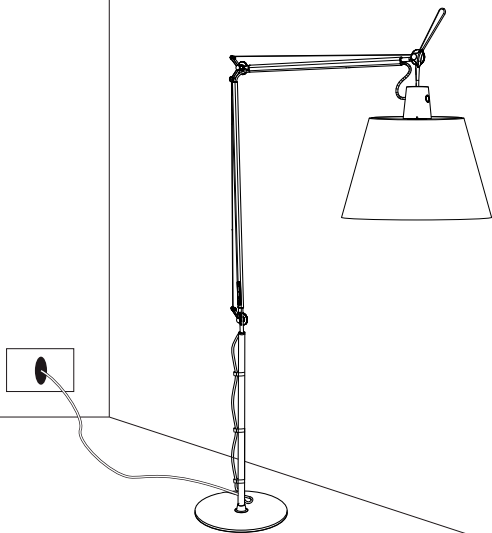

1

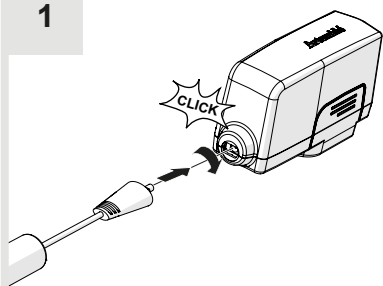

i

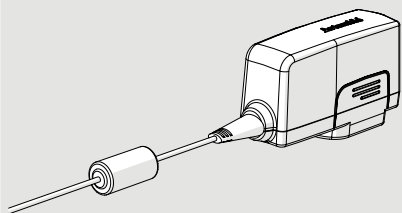
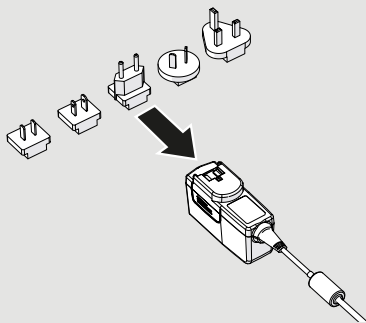

2

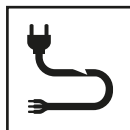
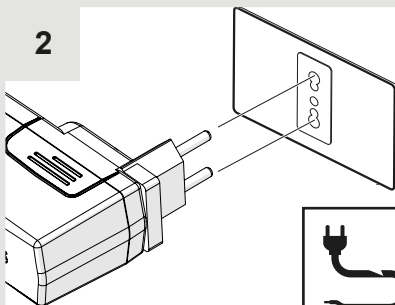

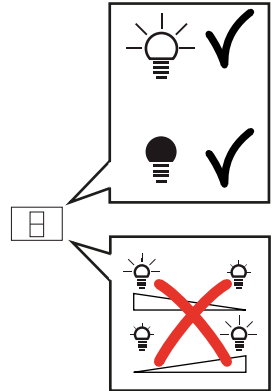
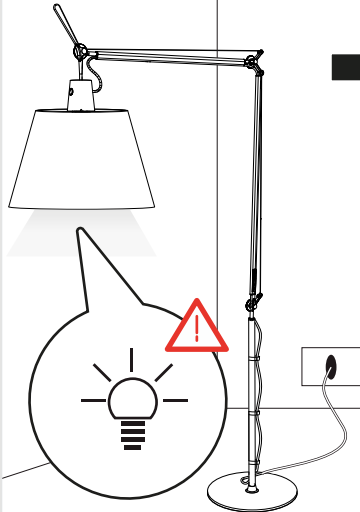
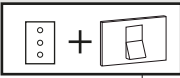
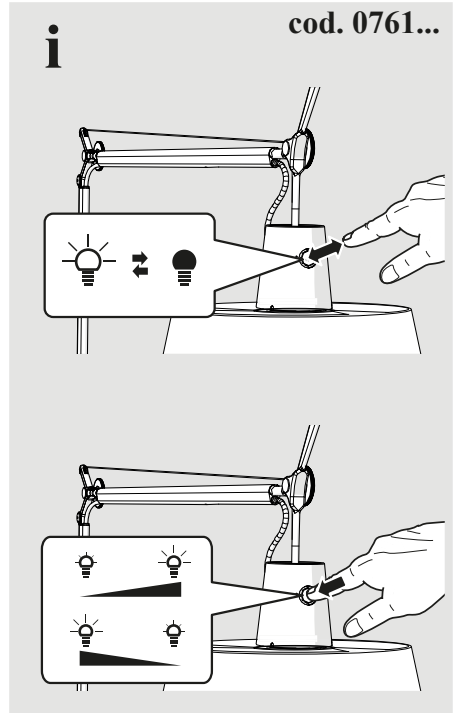
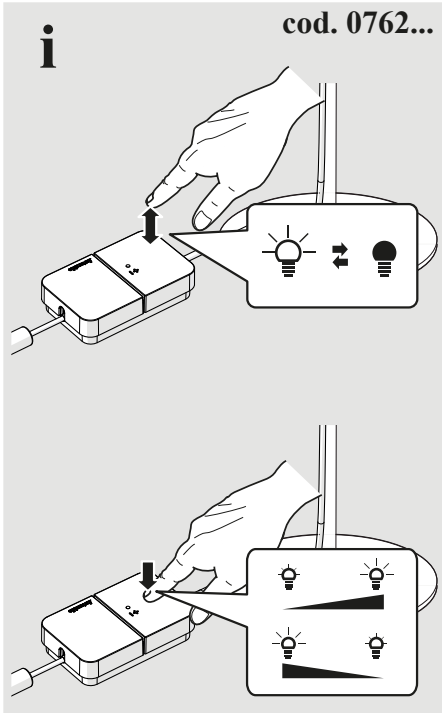



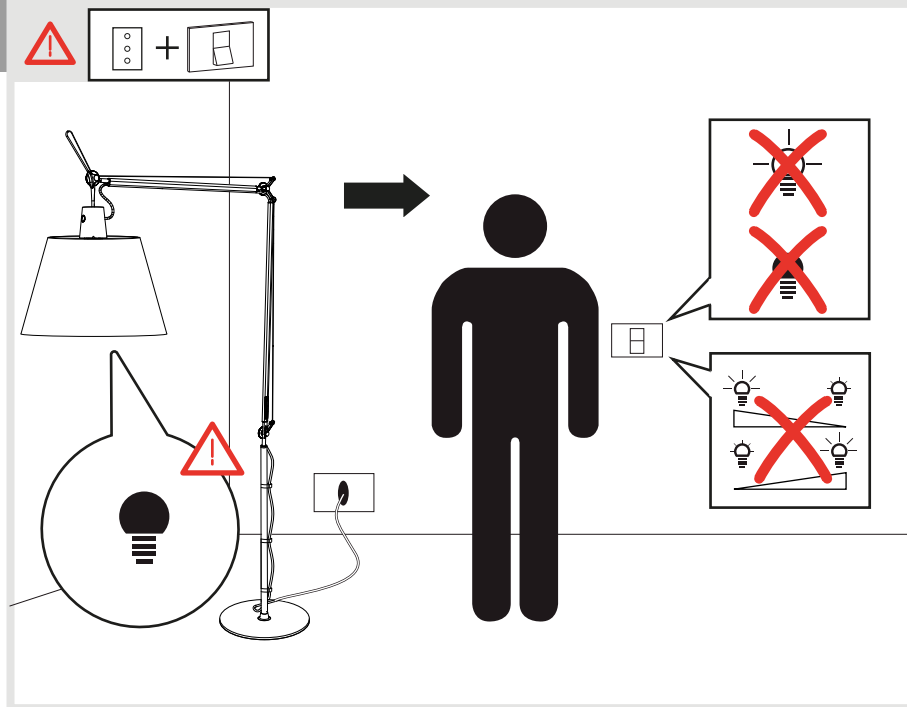

**i**



**1**

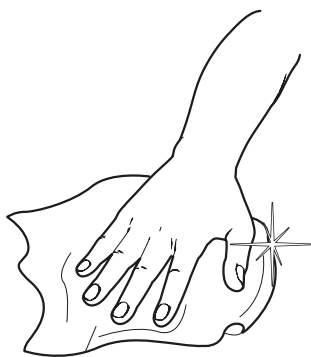

# i

- IT** Questo prodotto è dotato di un gruppo ottico con avanzata tecnologia di asportazione del calore, basata su una innovativa ventola a lievitazione magnetica a bassissimo rumore.  
L'intervento della ventola avviene in maniera attiva grazie all'elaborazione del segnale proveniente da un sensore di calore posto nel gruppo ottico. Questa tecnologia massimizza l'affidabilità e la durata del gruppo ottico garantendone sempre performance ottimali.
- EN** This product features an optical unit with advanced heat removal technology, based on an innovative low-noise magnetic levitation fan. The fan is actively operated by processing the signal from a heat sensor in the optic unit.  
This technology maximises the reliability and durability of the optical unit and ensures optimum performance at all times.
- FR** Ce produit est doté d'une unité optique avec une technologie avancée d'évacuation de la chaleur, basée sur un ventilateur innovant à lévitation magnétique à faible bruit.  
Le ventilateur fonctionne activement en traitant le signal d'un capteur de chaleur dans l'unité optique.  
Cette technologie maximise la fiabilité et la durabilité de l'unité optique et garantit des performances optimales à tout moment.
- ES** Este producto cuenta con una unidad óptica con tecnología avanzada de eliminación de calor, basada en un innovador ventilador de levitación magnética de bajo ruido.  
El ventilador se activa procesando la señal de un sensor de calor en la unidad óptica.  
Esta tecnología maximiza la fiabilidad y la durabilidad de la unidad óptica y garantiza un rendimiento óptimo en todo momento.
- DEU** Dieses Produkt verfügt über eine optische Einheit mit fortschrittlicher Wärmeabfuhrtechnologie, die auf einem innovativen, geräuscharmen Magnetschwebelüfter basiert.  
Der Ventilator wird aktiv betrieben, indem er das Signal eines Wärmesensors in der optischen Einheit verarbeitet.  
Diese Technologie maximiert die Zuverlässigkeit und Langlebigkeit der optischen Einheit und sorgt für eine optimale Leistung zu jeder Zeit.



# Artemide®



## **Artemide**

via Bergamo, 18  
20006 Pregnana M.se (MI)  
ITALIA

tel. +39 02 935 181  
fax +39 02 935 90 254  
fax +39 02 935 90 496

[www.artemide.com](http://www.artemide.com)

VAT IT00846890150

## **Artemide Inc.**

250 Karin Lane  
Hicksville, NY 11801

Tel. 631 694 9292  
Toll Free 1-877-Art-9111  
Fax 631 694 9275

[www.artemide.net](http://www.artemide.net)

## **Artemide Ltée/Ltd.**

11105 rue Renaude Lapointe  
Montréal, Québec H1J 2T4

Tel. 514 323 6537  
Toll Free 888 777 2783  
Fax 514 323 8864

[www.artemide.net](http://www.artemide.net)

cod. Y513000163K